

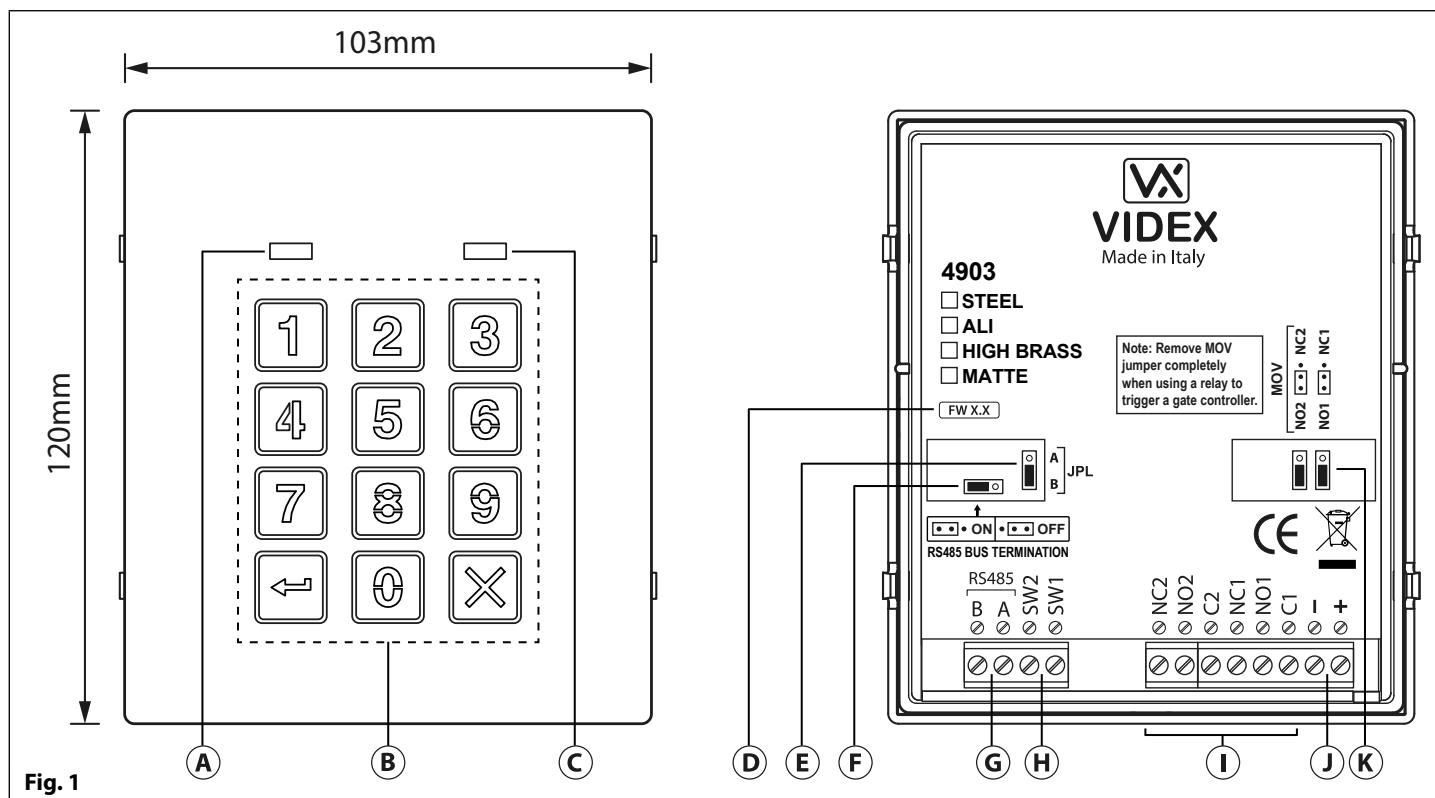



Art. 4903 Codelock Module for the GSMPRO



DESCRIPTION

The module features 12 stainless steel buttons, backlit in blue (keys 0-9, ENTER  and CLEAR ), 2 LED's (green LED = data, red LED = status indication) for progress information during use and programming and a stainless steel or aluminium front plate, see **Fig.1**. With two integral relays (RLY1 and RLY2) each with common (C), normally open (NO) and normally closed (NC) connections and two switched 0V push to exit inputs SW1 and SW2 to enable the external triggering of the relays. Key presses are signalled acoustically while each button press has a tactile feel. Entering the correct code followed by ENTER  will activate the relevant relay.

LEGEND

- (A) Data LED (green)
- (B) Backlit (blue) key buttons
- (C) Status indication LED (red)
- (D) Current firmware version (FW X.X)
- (E) Back light adjustment jumper (JPL)
- (F) RS485 bus termination jumper (JP1)
- (G) RS485 bus terminals
- (H) PTE terminals (SW1 and SW2)
- (I) Relay terminals (RLY1 and RLY2)
- (J) Power input terminals
- (K) Back EMF protection (JP2 and JP3)

OPERATION

In standby the both LED's on the front of the Art.4903 codelock (**Fig.1**, (A) and (C)) will be switched OFF.

Access Granted: To operate the required relay (RLY1 or RLY2) on the codelock type in the access code for the respective relay, via the keypad (**Fig.1** (B)), followed by ENTER . Once the correct code has been entered it will operate the respective relay for the programmed relay time. The green data LED (**Fig.1**, (A)) will flash once and the codelock will emit a series of beeps for the duration of the relay time.

Access Denied: If an incorrect access code is entered no relay will activate. The codelock will emit a low tone, the green data LED (**Fig.1**, (A)) will flash 4 times followed by a brief pause. The red status LED (**Fig.1**, (C)) will then flash once and the codelock will emit a single beep.

IMPORTANT NOTE: Both relays (RLY1 and RLY2) can also be activated via a push to exit button (configured as a push-to-make switch) when connected across - and SW1 for RLY1, - and SW2 for RLY2 respectively. It should also be noted that when the relay time has been set for latching (00) the push to exit button will operate as a "toggle" switch to latch the relay open and latch the relay closed.

LOCK RELEASE BACK EMF PROTECTION

A varistor must be fitted across the terminals of an AC lock release (see **Fig.2**) and a diode must be fitted across the terminals of a DC lock release (see **Fig.3**) to suppress back EMF voltages. Connect the components to the locks as shown.

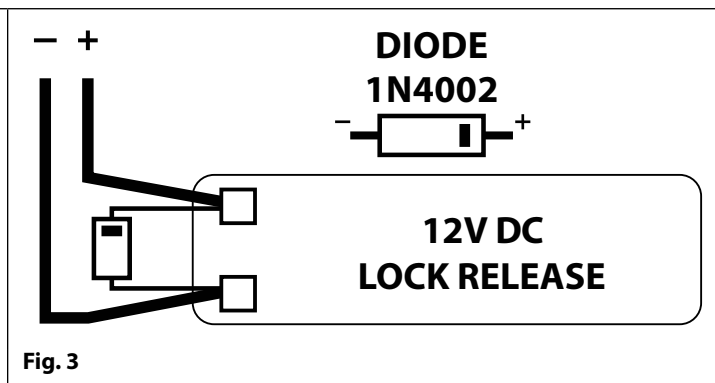
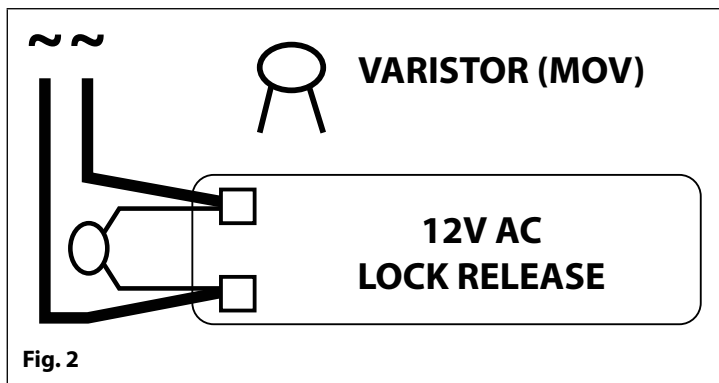

RS485 BUS TERMINATION JUMPER (JP1)

The jumper JP1 on the rear of the codelock sets the RS485 bus termination when connected to the Art.4810 GSM PRO or other RS485 devices. By default the jumper is set to the ON position (across to the left). When more than one RS485 device is connected to the keypad in line on the RS485 bus terminals then the jumper can be set to the OFF position (across to the right) and only set to the ON (closed) position on the end of line device, see Fig.4.

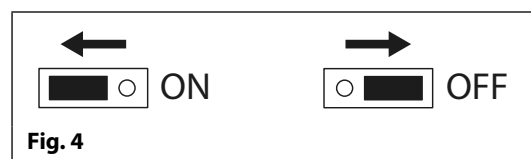

RELAYS BUILT-IN BACK EMF PROTECTION (JP2 AND JP3)

The Art.4903 codelock includes selectable back EMF protection (metal oxide varistors) jumpers JP2 and JP3 for each relay (marked MOV) and are used to select the protection type. When using a fail secure lock with connections C & NO the jumper should be in the NO position. When using a fail open (safe) lock with connections C & NC the jumper should be in the NC position, as shown in Fig.5. When using the codelock to trigger a gate controller or another third party controller the jumper should be removed completely (this disables the protection on the relay).

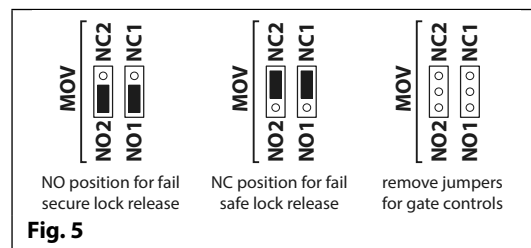

RESETTING THE CODELOCK BACK TO FACTORY DEFAULTS

IMPORTANT NOTE: WHEN RESETTING THE ART.4903 CODELOCK BACK TO FACTORY DEFAULTS IT WILL CLEAR ANY CODES PROGRAMMED VIA THE KEYPAD FOR RELAY 1 AND RELAY 2. IT WILL RESET THE ENGINEER'S CODE BACK TO 6x1 ("111111") AND RESET THE RELAY TIMES TO 5 SECONDS.

It should also be noted that when the Art.4903 codelock is connected to a GSM PRO module via the RS485 bus any codes programmed via SMS text messages and/or using the GSM SK PC software, i.e. 400 permanent codes, 32 temporary codes and any other parameters for these codes (timebands, access levels etc.also refer to the notes: programming when integrated with the GSM PRO on page 4) will not be affected by the reset. Also the codelock's unit ID will not be affected.

Follow the steps below to reset the codelock to factory defaults:

1. Remove/disconnect the power from the Art.4903 codelock;
2. Short out terminals - and SW2, see Fig.6;
3. Press and hold down the ENTER button and keep pressed down while the power is switched back ON;
4. When power is restored to the codelock wait for the module to emit a beep and wait for the red status LED (Fig.1, C) to stop flashing;
5. Release the ENTER button then remove the short between terminals - and SW2, see Fig.7;
6. The ENGINEER'S CODE has been reset back to the factory default, 6x1 ("111111"), relays reset to 5 seconds and internal access codes for RLY1 and RLY2 cleared.

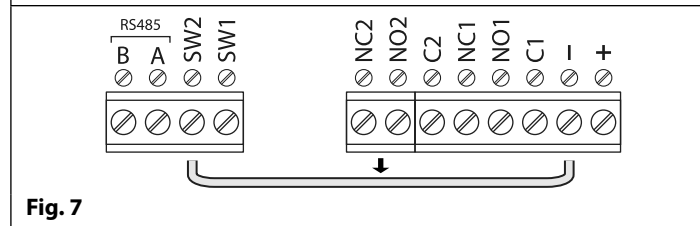
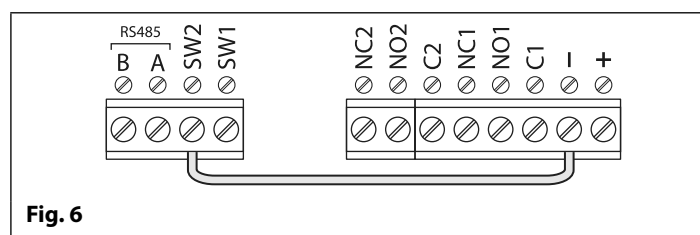





BACK LIGHT ADJUSTMENT JUMPER (JPL)

The jumper JPL (Fig.1, E) is used to adjust the brightness and determine the operation of the backlit buttons. There are four brightness settings for the backlit buttons and two programming modes (mode 1 and 2) for the jumper.

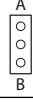

Art. 4903 Codelock Module for the GSM PRO

The two modes that can be programmed change the functionality of the jumper JPL. The table below indicates the programming mode, the position of the jumper and the operation of the backlit buttons.

| | | Jumper Position | Back light Operation |
|--------|----------------------------|--|--|
| Mode 1 | A (default) |  | Back light on low brightness in standby. Full brightness when any buttons are pressed. |
| | B |  | Back light OFF in standby. Full brightness when any buttons are pressed. |
| Mode 2 | A or B |  or  | Back light on full brightness all of the time. |
| | JPL removed in either Mode |  | No back light, the back light is completely disabled. |



PROGRAMMING MODE 1 (DEFAULT MODE, JPL = A)

Follow the steps below to set the codelock to mode 1:

1. Disconnect the power from the Art.4903 codelock;
2. Short out terminals - and SW2, see **Fig.6**, page 2;
3. Press and hold down button 1  and keep it pressed down while the power is switched back ON;
4. When power is restored to the codelock wait for the module to emit a single beep and the red status LED (**Fig.1**, **C**) to flash once;
5. Listen for the confirmation tone and wait for the red status LED (**Fig.1**, **C**) to flash once again;
6. Release button 1  and remove the short between terminals - and SW2, see **Fig.7**, page 2;
7. Set the jumper JPL to the desired position.

PROGRAMMING MODE 2

Follow the steps below to set the codelock to mode 2:

1. Disconnect the power from the Art.4903 codelock;
2. Short out terminals - and SW2, see **Fig.6**, page 2;
3. Press and hold down button 2  and keep it pressed down while the power is switched back ON;
4. When power is restored to the codelock wait for the module to emit a double beep and the red status LED (**Fig.1**, **C**) to flash once;
5. Listen for the confirmation tone and wait for the red status LED (**Fig.1**, **C**) to flash once again;
6. Release button 2  and remove the short between terminals - and SW2, see **Fig.7**, page 2;
7. Set the jumper JPL to the desired position.

BACK LIGHT AND BUTTON OPERATION



If the back light programming mode is set to mode 1 (with jumper JPL in either the A or B position) when a button is pressed on the keypad the back light will switch to full brightness for approximately 10 seconds.

After this time the back light will either switch OFF or switch back to low brightness (depending on the jumper position) unless another button has been pressed within the 10 second period in which case the back light will stay on full brightness for a further 10 seconds.

The exception to this is if the back light programming mode is set to mode 2, i.e. the back light will be on full brightness all of the time or if the jumper is removed the back light will be disabled.

SETTING UP THE UNIT ID OF THE KEYPAD (ID 1 - 8)

The unit ID is required when connecting the Art.4903 codelock to a GSM PRO module via the RS485 bus terminals when additional access codes and parameters for these codes (timebands, access levels etc.) are required (also refer to the notes: **programming when integrated with the GSM PRO** on page 5). Follow the steps below to setup the unit ID of the codelock:

1. Disconnect the power from the Art.4903 keypad, then short out terminals - and SW2, see **Fig.6**;
2. Press and hold down the 0  button, keeping it pressed while the power is switched back ON;
3. When power is restored to the keypad first the backlit key buttons will illuminate (**Fig.1**, **B**). Wait for the keypad to emit a low level tone then wait for the red status LED (**Fig.1**, **C**) to switch ON;
4. Release the 0  button then enter the unit ID required for the Art.4903 (1 - 8) using the keypad (**Fig.1**, **B**). The red status LED will switch OFF and the keypad will play a short melody. Observe the red status LED (**Fig.1**, **C**) as this will flash as many times as the unit ID being set (e.g. if the unit ID is set to ID.8 the red status LED will flash 8 times);
5. After the red status LED stops flashing remove the short between terminals - and SW2, see **Fig.7**, the unit ID has been set.







Art. 4903 Codelock Module for the GSMPRO

PROGRAMMING AS A STANDALONE KEYPAD



When using the Art.4903 as a standalone keypad the programming is the same as the programming of an Art.4800M keypad (refer to the following programming guide and flowchart). All programming is carried out using the keypad. The programming menu is protected by an **ENGINEER'S CODE**, the factory default of which is six times 1 ("111111"). This code can be changed to any 4 to 8 digit **ENGINEER'S CODE** during the programming and is used to gain entry to the programming menu only.

Each relay (**RLY1** and **RLY2**) can be programmed with a 4 - 8 digit access code (one code per relay) and will activate the respective relay for the programmed relay time (01 - 99 seconds or 00 for latching). The access code programmed is stored in the keypads internal memory.

PROGRAMMING GUIDE

- Enter the **ENGINEER'S CODE**: first time type six times 1 (111111 factory default) and press **ENTER**  to confirm, (the red LED will illuminate);
- Confirm **ENGINEER'S CODE**: re-type the same code again **or** type a new code (4 to 8 digits) then press **ENTER**  to confirm, (melody);
- Enter the code (4 to 8 digits) to enable **RELAY 1** then press **ENTER**  to confirm, (melody);
- Enter the **RELAY 1** operation time (2 digits 01 to 99, i.e. 05 = 5 seconds, 00 = latch) then press **ENTER**  to confirm, (melody);
- Enter the code (4 to 8 digits) to enable **RELAY 2** then press **ENTER**  to confirm, (melody);
- Enter the **RELAY 2** operation time (2 digits 01 to 99, i.e. 05 = 5 seconds, 00 = latch) then press **ENTER**  to confirm, (melody);
- Press **ENTER**  twice again to exit programming (melody);
- The system is ready to use (the red LED will switch OFF).

PROGRAMMING NOTES

- Pressing the **ENTER**  button twice during the programming process, without changing any parameters, will exit from the programming menu.
- When entering a relay code it must be different from the **ENGINEER'S CODE**.
- To latch the relay type in the access code then press **ENTER**  to confirm. To unlatch the relay type in the same access code again then press **ENTER**  to confirm.

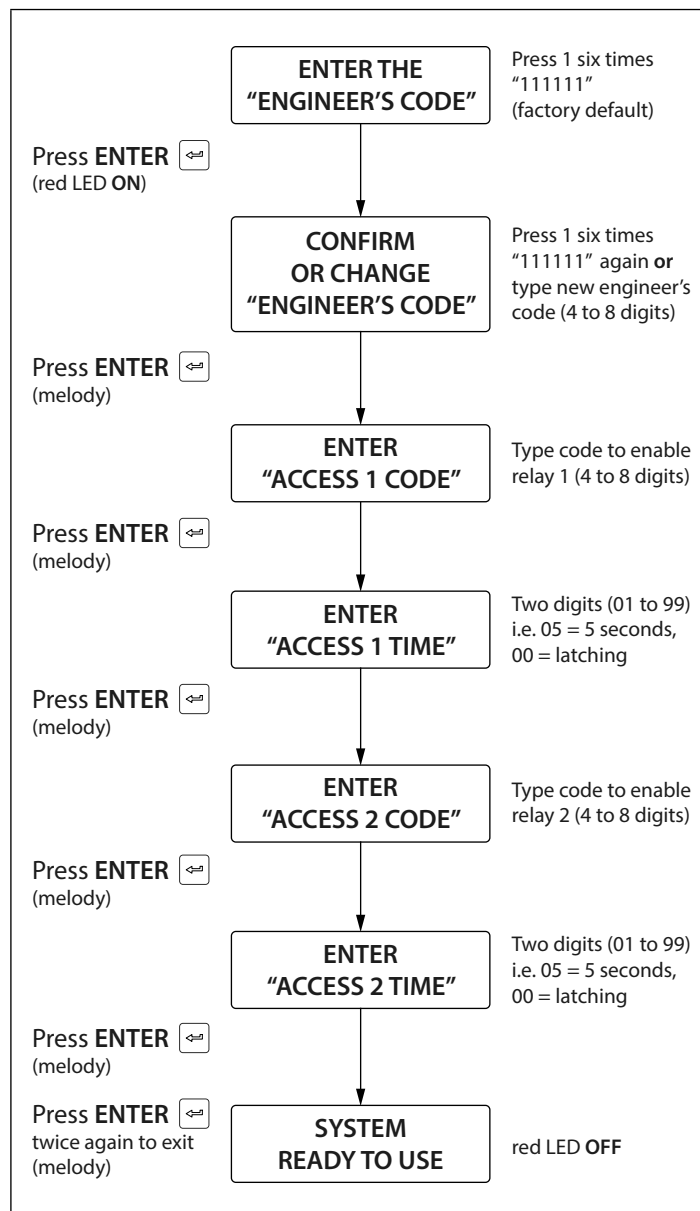

Art. 4903 Codelock Module for the GSMPRO

PROGRAMMING WHEN INTEGRATED WITH THE GSM PRO (ART.4810 MODULE VIA THE RS485 BUS TERMINALS)

The Art.4903 can also be programmed using the GSM SK PC software (refer to the manual: [GSM SK_66251720_EN_V2-0](#) or later) and also via text messaging (refer to the technical manual: [GSM4KCR_66250754_EN_V1-0](#) or later).

When wired directly to the GSM PRO module using the RS485 bus terminals, see **Fig.8**, additional access code features of the GSM PRO module become available which include:

- program up to 400 permanent access codes (000 - 399);
- assign any of the 400 access codes to an access level (0 - 9) and relay;
- program up to 32 temporary access codes;
- allocate any of the 32 temporary codes to a specific time period (between 1 - 255 hours) after which time the code will be deleted;
- assign any of the access codes, whether permanent or temporary, to trigger any or a combination of the two relays (RLY1 and/or RLY2).

The access codes can be 4 - 8 digits in length and are stored in the Art.4810 GSM PRO module's memory and not the codelock.

Even when the Art.4903 is connected to the GSM PRO module via the RS485 bus any access codes programmed directly using the keypad (**Fig.1, B**) following the programming flowchart on page 3, for relays 1 and 2 (as if the keypad were programmed as a standalone keypad) will still operate the respective relay.

The RS485 connection also allows the keypad to be networked with other RS485 devices including additional Art.4903 keypads and Art.4850R expansion proximity readers where each module requires a unique unit ID to be setup (up to a total of 8 devices), also refer to **setting up the unit ID of the keypad** on pages 3.

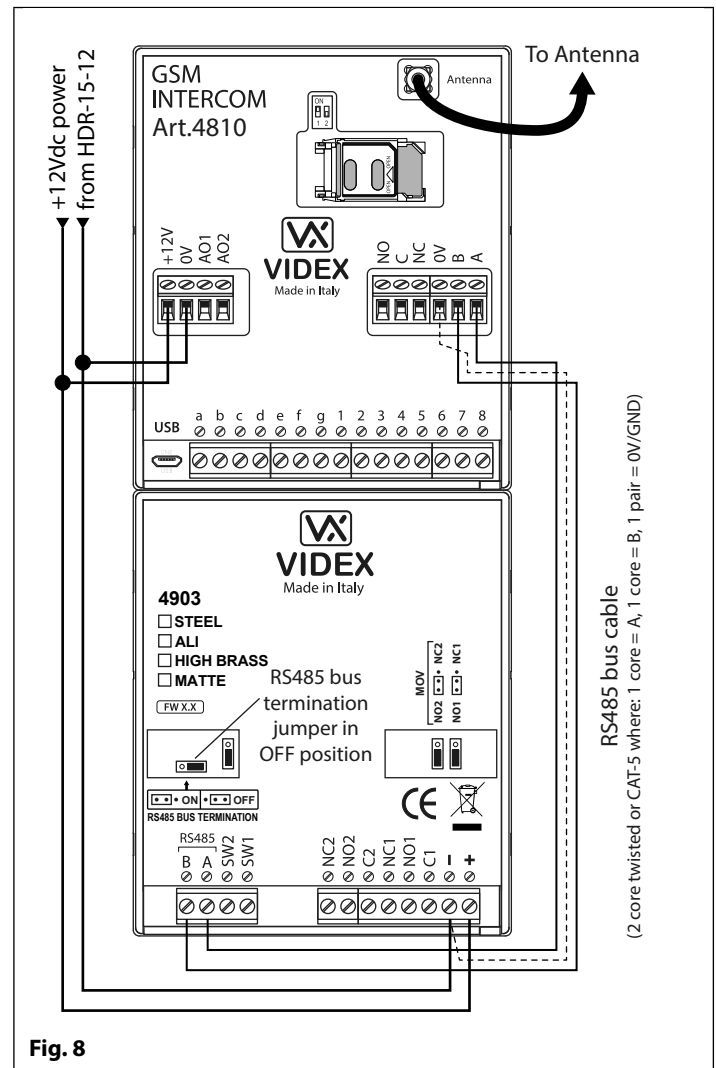

Fig. 8

Please note that for the RS485 bus cable over a short distance, as shown in **Fig.8**, the bus termination jumper on the keypad should be set to **OFF** and a 120Ω resistor is not required across terminals A / B on the Art.4810 GSM PRO module. The RS485 bus termination is only required when additional RS485 devices are connected on the RS485 bus over longer distances (refer to additional RS485 notes in the technical manual: [GSM4KCR_66250754_EN_V1-0](#) or later for more information).

ADHESIVE GASKET PLACEMENT

Apply the gasket seal (Y) as shown in **Fig.9**.

ANTI-TAMPERING LOCK BRACKETS

Fit the anti-tampering lock brackets (W) as shown in **Fig.10**.

CLEANING OF THE PLATE

Use a clean and soft cloth. Use moderate warm water or non-aggressive cleansers. When cleaning always follow the grain of the metalwork on panels with a matte finish.

Do not use:

- abrasive liquids;
- chlorine-based liquids;
- metal cleaning products.

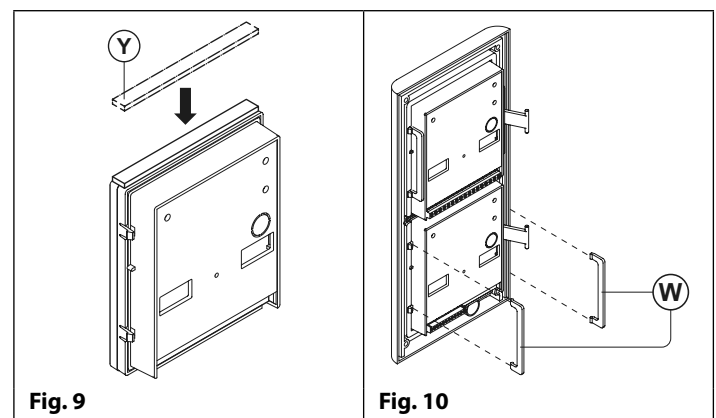

Fig. 9

Fig. 10

Art. 4903 Codelock Module for the GSMPRO

TERMINAL CONNECTIONS

| Connection | Description |
|------------|--------------------------------------|
| + | 12-24V AC or DC power input |
| - | 0V power input |
| C1 | Relay 1 common connection |
| NO1 | Relay 1 normally open connection |
| NC1 | Relay 1 normally closed connection |
| C2 | Relay 2 common connection |
| NO2 | Relay 2 normally open connection |
| NC2 | Relay 2 normally closed connection |
| SW1 | Switched 0V input to trigger relay 1 |
| SW2 | Switched 0V input to trigger relay 2 |
| A | RS485 bus terminal connections |
| B | |

Relay contacts:
3A @ 24Vac/dc
(max.)

TECHNICAL SPECIFICATION

Working voltage: 12V - 24Vac/dc +/- 10%
Current consumption: 20mA (standby), 70mA (max.)
Number of relays: 2, RLY1 and RLY2 (C, NC and NO)
Relay current/voltage: 3A @ 24Vac/dc (max.)
Push to exit inputs: 2, SW1 and SW2 (switched 0V)
RS485 bus connections: Yes, A and B
RS485 termination: Jumper JP1
Back light adjustment: Jumper JPL
Networkable: Yes via RS485 (8 devices max.)
Back EMF protection: 2x MOV jumpers, JP2 and JP3
Number of codes: 2 codes, 1 per relay (standalone);
 400 permanent codes (via RS485);
 32 temporary codes (via RS485)
Programming: Via keypad (standalone);
 SMS text message (via RS485);
 GSM SK PC software (via RS485)
Working Temperature: -10 +50°C



IT IS RECOMMENDED THAT ANY CABLING AND VIDEX PRODUCTS BE INSTALLED BY A COMPETENT AND QUALIFIED ELECTRICIAN, SECURITY INSTALLATION SPECIALIST OR COMMUNICATIONS ENGINEER.

WIRING DIAGRAM (AS STANDALONE KEYPAD)

NOTES:

The HDR-15-12 power supply requires 230Vac (50/60Hz) mains input.

A fail safe (mag lock) is shown, for fail secure lock release wiring first remove the emergency break glass unit from the lock circuit. Next move the lock wire from NC1 across to the NO1 terminal. Also set the MOV jumper to the NO1 position.

For connections to gate controls wire into terminals C1 / NO1 if using relay 1 and terminals C2 / NO2 if using relay 2. Also remove the respective MOV jumper.

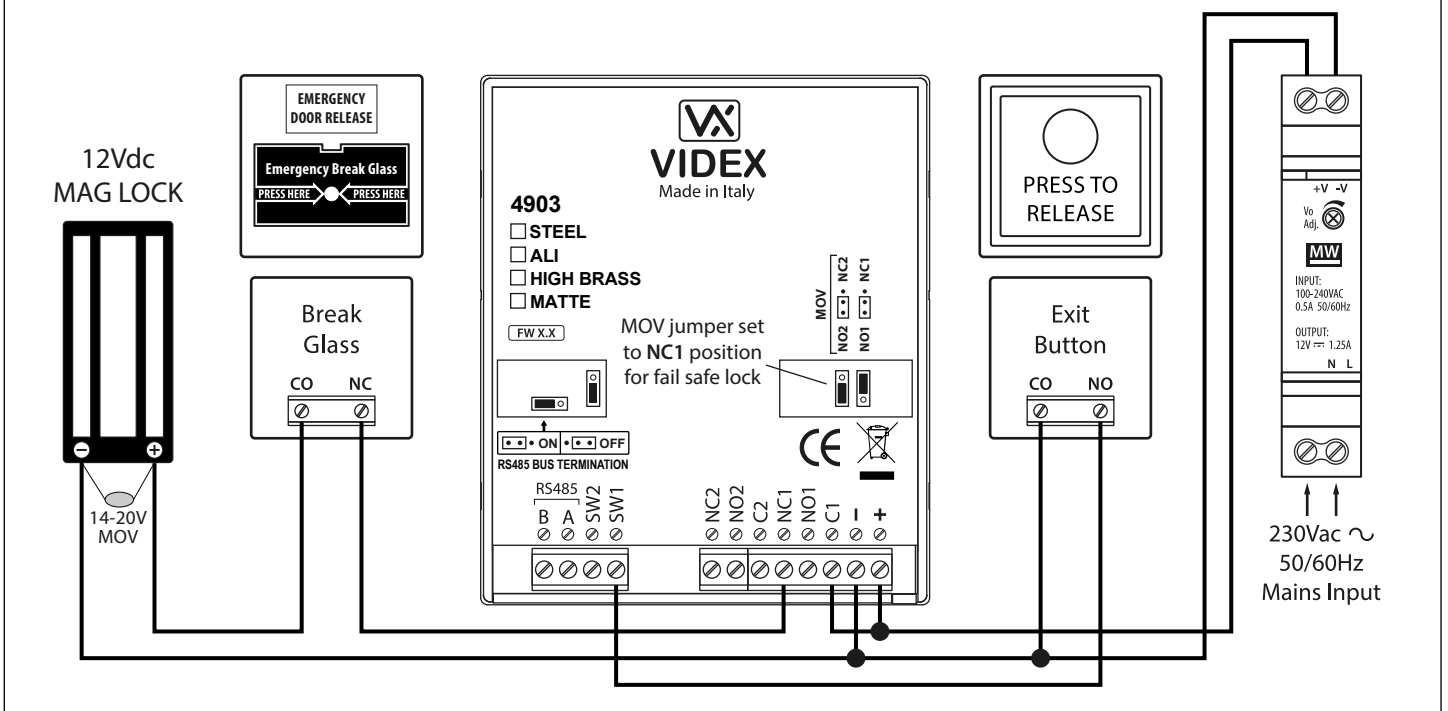

For RS485 network connection, cabling information and installation notes refer to the wiring diagram on page 7.

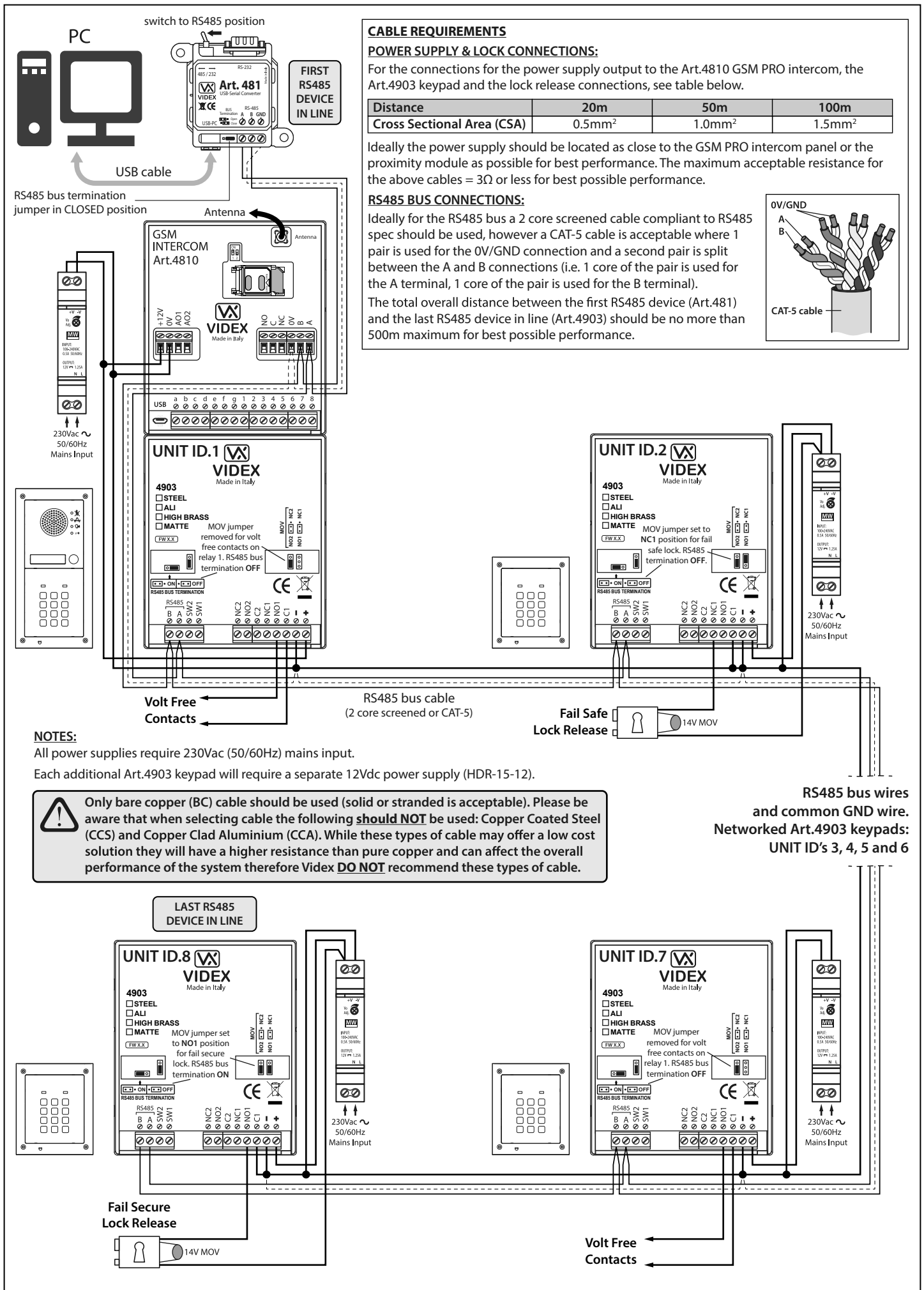

CABLE REQUIREMENTS

POWER SUPPLY & LOCK CONNECTIONS:

For the connections for the power supply output to the Art.4810 GSM PRO intercom, the Art.4903 keypad and the lock release connections, see table below.

| Distance | 20m | 50m | 100m |
|----------------------------|--------------------|--------------------|--------------------|
| Cross Sectional Area (CSA) | 0.5mm ² | 1.0mm ² | 1.5mm ² |

Ideally the power supply should be located as close to the GSM PRO intercom panel or the proximity module as possible for best performance. The maximum acceptable resistance for the above cables = 3Ω or less for best possible performance.

RS485 BUS CONNECTIONS:

Ideally for the RS485 bus a 2 core screened cable compliant to RS485 spec should be used, however a CAT-5 cable is acceptable where 1 pair is used for the 0V/GND connection and a second pair is split between the A and B connections (i.e. 1 core of the pair is used for the A terminal, 1 core of the pair is used for the B terminal).

The total overall distance between the first RS485 device (Art.481) and the last RS485 device in line (Art.4903) should be no more than 500m maximum for best possible performance.

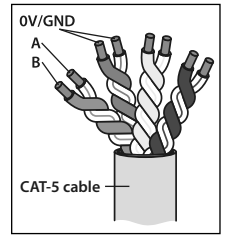

NOTES:

- All power supplies require 230Vac (50/60Hz) mains input.
- Each additional Art.4903 keypad will require a separate 12Vdc power supply (HDR-15-12).

Only bare copper (BC) cable should be used (solid or stranded is acceptable). Please be aware that when selecting cable the following should NOT be used: Copper Coated Steel (CCS) and Copper Clad Aluminium (CCA). While these types of cable may offer a low cost solution they will have a higher resistance than pure copper and can affect the overall performance of the system therefore Videx **DO NOT recommend these types of cable.**

RS485 bus wires and common GND wire.
Networked Art.4903 keypads:
UNIT ID's 3, 4, 5 and 6

Notes

Dotted lines for writing notes.

Notes

Lined area for taking notes, consisting of multiple horizontal dashed lines.

Notes

A series of horizontal dashed lines spanning the width of the page, intended for taking notes.

ENG DISPOSAL

In accordance with the Legislative Decree no. 49 of 14 March 2014 "Implementation of the Directive 2012/19/EU on waste electrical and electronic equipment (WEEE)".

The crossed-out bin symbol on the equipment or on the packaging indicates that when the product reaches the end of its lifetime, it must be collected separately from mixed municipal waste. The user must, therefore, dispose of the equipment at the end of its lifetime in the suitable waste collection centres or bring it to the retailer during the purchase of a new equipment of equivalent type at the ratio of one-to-one. Furthermore, the user is allowed to dispose of the WEEEs of very small size (domestic appliances without any external dimension exceeding 25 cm (9.84 inches) for free to the retailers, without any purchase obligation. The correct waste disposal of the WEEEs contributes to their reuse, recycling and recovery and avoids potential negative effects on the environment and human health due to the possible presence of dangerous substances within them.

ITA SMALTIMENTO

Ai sensi del Decreto Legislativo 14 marzo 2014, n° 49 "Attuazione della direttiva 2012/19/UE sui rifiuti di apparecchiature elettriche ed elettroniche (RAEE)".

Il simbolo del cassonetto barrato riportato sull'apparecchiatura o sulla sua confezione indica che il prodotto alla fine della propria vita utile deve essere raccolto separatamente dagli altri rifiuti urbani misti. L'utente dovrà, pertanto, conferire l'apparecchiatura giunta a fine vita presso gli idonei centri di raccolta differenziata oppure riconsegnarla al rivenditore al momento dell'acquisto di una nuova apparecchiatura di tipo equivalente, in ragione di uno a uno. L'utente ha, inoltre, la possibilità di conferire gratuitamente presso i distributori, senza alcun obbligo di acquisto, per i RAEE di piccolissime dimensioni (per le apparecchiature di tipo domestico con nessuna dimensione esterna superiore a 25 cm). L'adeguata raccolta differenziata dei RAEE contribuisce al loro riutilizzo, riciclaggio e recupero ed evita potenziali effetti negativi sull'ambiente e sulla salute umana dovuti alla eventuale presenza di sostanze pericolose al loro interno.

FRA ÉLIMINATION

Conformément au décret législatif n° 49 du 14 mars 2014 relatif à l'« Application de la directive 2012/19 / UE relative aux déchets d'équipements électriques et électroniques (DEEE) ».

Le symbole de la poubelle barrée sur l'équipement ou sur son emballage indique que le produit en fin de vie utile doit être collecté séparément des autres déchets municipaux en mélange. L'utilisateur doit donc remettre l'équipement en fin de vie aux centres de collecte appropriés ou le restituer au revendeur lors de l'achat d'un nouveau type d'équipement équivalent, dans le rapport de un à un. De plus, l'utilisateur a la possibilité de conférer gratuitement aux distributeurs, sans aucune obligation d'achat, de très petits DEEE (pour les appareils ménagers sans dimensions extérieures supérieures à 25 cm). La collecte séparée adéquate des DEEE contribue à leur réutilisation, leur recyclage et leur valorisation et évite les éventuels effets négatifs sur l'environnement et la santé humaine en raison de la présence possible de substances dangereuses dans ceux-ci.

SPA ELIMINACIÓN

De conformidad con el Decreto legislativo n. 49 de 14 de marzo 2014 "Aplicación de la Directiva 2012/19/UE relativa a residuos de aparatos eléctricos y electrónicos (RAEE)".

El símbolo del contenedor tachado indicado sobre los aparatos o sobre los embalajes señala que el producto al final de su vida útil debe ser recogido separadamente de otros residuos municipales mezclados. Por tanto, el usuario deberá conferir los aparatos al final de su vida útil en los apropiados centros de recogida selectiva o devolverlos al revendedor al momento de la compra de nuevos aparatos equivalentes, en una relación de uno a uno. Además, el usuario tiene la posibilidad de entregar sin cargo a los distribuidores, sin ninguna obligación de compra, los RAEEs muy pequeños (para electrodomésticos sin dimensiones externas superiores a 25 cm).

La recogida selectiva apropiada de los RAEEs contribuye a su reutilización, reciclaje y valorización y evita potenciales impactos negativos sobre el medio ambiente y la salud humana debidos a la posible presencia de sustancias peligrosas dentro de ellos.

NLD VERWIJDERING

In overeenstemming met het Wetsbesluit nr. 49 van 14 maart 2015 "Implementatie van de Richtlijn 2012/19/EU inzake afgedankte elektrische en elektronische apparaten (AEEA)".

Het doorgekruiste vuilnisbaksymbool op het apparaat of de verpakking geeft aan dat het product aan het einde van zijn levensduur niet samen met het gewone huisvuil weggegooid mag worden. De gebruiker moet het apparaat aan het einde van zijn levensduur inleveren bij een gepast inzamelpunt of de winkel waar hij een nieuw apparaat van een gelijksoortig type zal kopen. De gebruiker kan tevens AEEA's van een zeer klein formaat (huishoudapparaten met een buitenafmeting kleiner dan 25 cm (9,84 inch)) gratis en zonder enige aankoopverplichting bij handelaars inleveren. Een juiste verwijdering van AEEA's draagt bij tot hergebruik, recycling en terugwinning, en voorkomt potentiële negatieve effecten op het milieu en de menselijke gezondheid door de mogelijke aanwezigheid van gevaarlijke stoffen.

| | | |
|---|--|--|
| MANUFACTURER FABBRICANTE FABRICANT FABRICANTE FABRIKANT الشركة المصنعة | VIDEX ELECTRONICS S.P.A. Via del Lavoro, 1 63846 Monte Giberto (FM) Italy Tel (+39) 0734 631669 Fax (+39) 0734 632475 www.videx.it - info@videx.it | |
| CUSTOMER SUPPORT SUPPORTO CLIENTI SUPPORTS CLIENTS ATENCIÓN AL CLIENTE KLANTENDIENST خدمة العملاء | VIDEX ELECTRONICS S.P.A. www.videx.it - technical@videx.it Tel: +39 0734-631669 Fax: +39 0734-632475 | UK Customers only: VIDEX SECURITY LTD www.videxuk.com Tech Line: 0191 224 3174 Fax: 0191 224 1559 |

*Main UK office:***VIDEX SECURITY LTD**

1 Osprey Trinity Park
Trinity Way
LONDON E4 8TD
Phone: (+44) 0870 300 1240
Fax: (+44) 020 8523 5825
www.videxuk.com
marketing@videxuk.com

*Northern UK office:***VIDEX SECURITY LTD**

Unit 4-7
Chillingham Industrial Estate
Chapman Street
NEWCASTLE UPON TYNE - NE6 2XX
Tech Line: (+44) 0191 224 3174
Phone: (+44) 0870 300 1240
Fax: (+44) 0191 224 1559

*Greece office:***VIDEX HELLAS Electronics**

48 Filolaou Str.
11633 ATHENS
Phone: (+30) 210 7521028
(+30) 210 7521998
Fax: (+30) 210 7560712
www.videx.gr
videx@videx.gr

*Danish office:***VIDEX DANMARK**

Hammershusgade 15
DK-2100 COPENHAGEN
Phone: (+45) 39 29 80 00
Fax: (+45) 39 27 77 75
www.videx.dk
videx@videx.dk

*Benelux office:***NESTOR COMPANY NV**

E3 laan, 93
B-9800 Deinze
Phone: (+32) 9 380 40 20
Fax: (+32) 9 380 40 25
www.videx.be
info@videx.be

*Dutch office:***NESTOR COMPANY BV**

Business Center Twente (BCT)
Grotestraat, 64
NL-7622 GM Borne
www.videxintercom.nl
info@videxintercom.nl



The product is CE marked demonstrating its conformity and is for distribution within all member states of the EU with no restrictions. This product follows the provisions of the European Directives 2014/30/EU (EMC); 2014/35/EU (LVD); 2011/65/EU (RoHS); CE marking 93/68/EEC.

Le produit est marqué CE à preuve de sa conformité et peut être distribué librement à l'intérieur des pays membres de l'union européenne EU. Ce produit est conforme aux directives européennes 2014/30/EU (EMC); 2014/35/EU (LVD); 2011/65/EU (RoHS); marquage CE 93/68/EEC.

Het product heeft de CE-markering om de conformiteit ervan aan te tonen en is bestemd voor distributie binnen de lidstaten van de EU zonder beperkingen. Dit product volgt de bepalingen van de Europese Richtlijnen 2014/30/EU (EMC); 2014/35/EU (LVD); 2011/65/EU (RoHS); CE-markering 93/68/EEC.

Il prodotto è marchiato CE a dimostrazione della sua conformità e può essere distribuito liberamente all'interno dei paesi membri dell'Unione Europea UE. Questo prodotto è conforme alle direttive Europee: 2014/30/UE (EMC); 2014/35/UE (LVD); 2011/65/UE (RoHS); marcatura CE 93/68/EEC.

El producto lleva la marca CE que demuestra su conformidad y puede ser distribuido en todos los estados miembros de la unión europea UE. Este producto cumple con las Directivas Europeas 2014/30/EU (EMC); 2014/35/EU (LVD); 2011/65/EU (RoHS); marca CE 93/68/EEC.

يحمل المنتج علامة التوافق الأوروبي CE لإظهار توافقه مع المواصفات ذات الصلة وإمكانية توزيعه في كافة دول الاتحاد الأوروبي بدون أية قيود. يلبّي هذا المنتج جميع متطلبات التوجيهات الأوروبية 2014/30/UE (EMC); 2014/35/UE (LVD); 2011/65/UE (RoHS); علامة المطابقة للمواصفات الأوروبية 93/68/EEC.



66251800-EN